

Your Solution
Partner In
Industrial Valve Automation...



2/2 & 3/2 WAY PNEUMATIC DIAPHRAGM OPERATED Control Valve

MODEL : PLC



Mfg. & Mkt by
aira Euroautomation pvt. ltd.

INDIA

www.airaindia.com



About Us

Clients are why we exist!

We welcome and thank you for referring out detailed catalogue.

aira is know all over continents as a manufacturer of quality products - Ball Valves, Butterfly Valves, Plug Valves, & Control On / Off Valves with Pneumatic Actuators for Pharma, Oil & Gas, Steel, Paper, Water, Chemical and all type of processing industries.

aira has walked through more than 3 decades, gaining valuable experience, offering equipment's in the products manufactured by OEMs in all spheres of engineering. **aira** products have gained reputations of consultants, and approvals of users, OEMs and other as a quality product.

aira has expanding business into foreign markets specially GCC, UAE, Asian & African countries. This is because increase its customer base and revenue, leading to overall growth and success. Now foreign users come to know and believe in the services provided by the **aira**. Along with the same, it also helps to reach a large number of users thereby leading to the increase their business.

Being and ISO 9001 BVQI certified company has put **aira** in fore front. Out motto is "Value the customer" and "Superior product", one among the best in the world.

Our Quality

- In- House full scale testing facility.
- Lean manufacturing practices
- Certified by : ISO 9001 : 2015 (BVQI LONDON), CE, ATEX, CIMFR, BIS, PESO, SIL 3, IBR
- API 609, API 6D

Our Commitment

- To understand customer's need first before proposing our products.
- To keep on providing competitive rate's by adapting to continuous process improvement, without compromising on quality.
- To provide continuous support to our customers and go beyond their expectations in terms of delivery and after sale services.

Our Manufacturing Facility

- In house R & D, manufacturing and testing facility is all located in a spread over three campuses at Ahmedabad, Gujarat, INDIA.

Network - Sales Office

- 60 Plus Branch Offices in different states in India.
- Sales office in the Bangladesh, Dubai, Kenya, Malaysia, Nepal, Qatar, Singapore, South Africa, Sri Lanka, Turkey, USA (Expanding).

QMS (Quality Management System)

ISO 9001 : 2015

EMS (Environment Management System)

ISO 14001 : 2015

OHSAS (Occupational Health & Safety Management System)

ISO 45001 : 2018

IBR
PISTON VALVE
GLOBE CONTROL VALVE (CKD/CND)
DISC CHECK VALVE (DCV)
PRESSURE REDUCING VALVE (PRV)
POP TYPE SAFETY VALVE
BALL VALVE

Pneumatic Actuator

CE /
ATEX /
EXIDA SIL-3 /
PROOF OF DESIGN

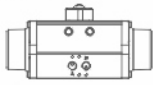

Scotch & Yoke Actuator

CE / ATEX / SIL-3

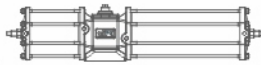

Stainless Steel Actuator

CE /
IEP ATEX



Positioner Enclosure

CE / CIMFR /
IP67 / BIS
/ PESO



aira's
SOME OF OUR
Certificates

Plug Valve

FUGITIVE EMISSIONS
TEST
AS PER ISO
15848-1 / IBR

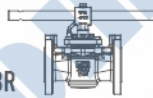

Flameproof Solenoid Valve

IEP ATEX / CE / CIMFR
/ IP65 / IP67 / IP68 /
BIS / PESO

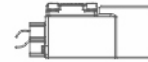

Limit Switch

IEP ATEX / CE / CIMFR
/ IP67 / BIS / PESO /
EQDC IP68

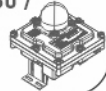

Ball Valve (Floating & Trunnion)

FIRE SAFE TEST DESIGN /
FUGITIVE EMISSIONS TEST
AS PER ISO 15848-1 / CE /
PED / API 6D / API 607 /
EXIDA SIL-3

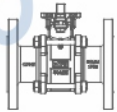

Butterfly Valve (centric / Double & Triple Eccentric)

FIRE SAFE TEST DESIGN /
FUGITIVE EMISSIONS TEST
AS PER ISO 15848-1 / CE /
PED / API 609 / EXIDA SIL-3
/ IBR / PROOF OF DESIGN /
FOOD GRADE / BIS / ISI



Multiport Ball Valve

FUGITIVE EMISSIONS TEST
AS PER ISO 15848-1 / CE /
PED / EIL

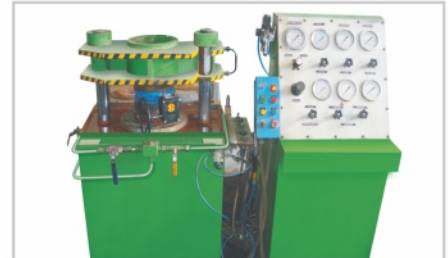
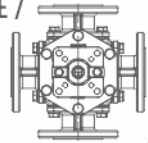

2/2 & 3/2 Way Pneumatic Cylinder Operated "PLC" Model Control Valve



"aira" Offers 2/2 - 3/2 way pneumatic Cylinder operated precise Regulating design control valve for Steam & Water Upto 200 °C

Size Range : 1/2" to 4" Flanged

Cylinder Specification	
Type	Single Acting Cylinder
Barrel	Aluminium
Shaft	EN 8 Hard Chrome Plated
Seals	Buna - N
End Cover	Cast Iron
Working Pressure	4.5 Kg/cm ²

Valve Specification	
Type of Valve	Globe Type 2/2 & 3/2 Way
Trim / Plug	S. S. 304
Working Pressure	7 Kg/cm ²
Working Temperature	Upto 220 °C Max.
Plug Design	On - Off Type
Testing Code	FCI 70 2
End Connection	ASME B16.5
Leakage Class	Class VI
Type of Bonnet	STD.



Model : PLC

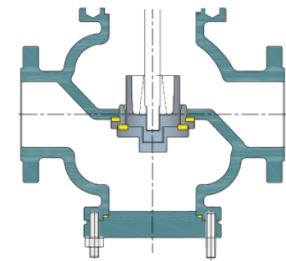
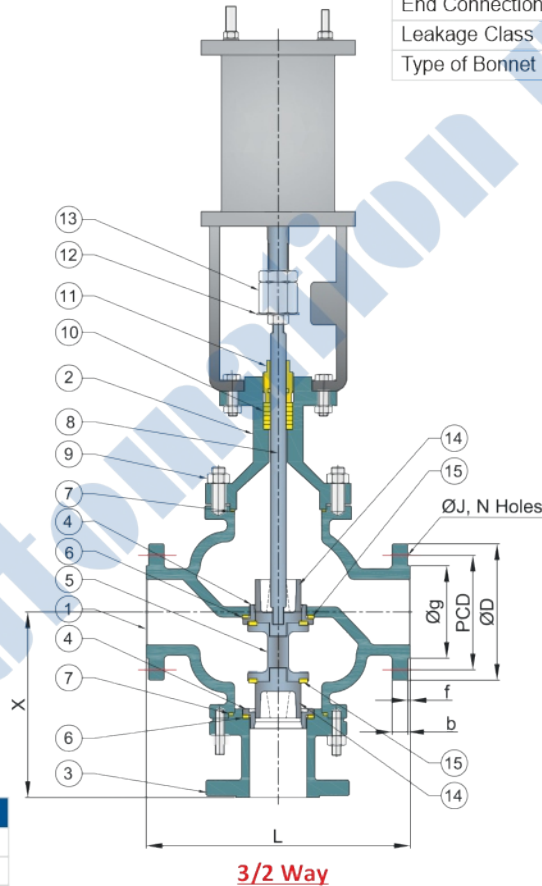

2/2 Way

Sr. No.	Description	Material
1	Body	WCB
2	Bonnet	WCB
3	Tail Piece / Cover Plate	WCB
4	Seat Ring	S. S. 304
5	T. S. Guide	S. S. 304
6	Seat Gasket	S. S. 304 Spiral Wound
7	Body Gasket	S. S. 304 Spiral Wound
8	Stem	S. S. 304
9	Stud + Nut	ASTMA 193 / B7-2H
10	Stem Packing	Wire Braided Graphite
11	Gland Nut	S. S. 304
12	Travel Indicator	S. S. 202
13	Connecting Nut	S. S. 304
14	T. S. Plug	S. S. 304
15	Seat	CFT

Dimensions :

VALVE MODEL	Size		L	PCD	Øg	ØD	b	f	ØJ	N	*X
	MM	Inch									
PLC - 15	15	1/2"	184	60.3	34.9	90	8	2	15.9	4	145
PLC - 20	20	3/4"	184	69.9	42.9	100	8.9	2	15.9	4	145
PLC - 25	25	1"	184	79.4	50.8	110	9.6	2	15.9	4	145
PLC - 40	40	1.1/2"	222	98.4	73	125	12.7	2	15.9	4	160
PLC - 50	50	2"	254	120.7	92.1	150	14.3	2	19.05	4	180
PLC - 65	65	2.1/2"	276	139.7	104.8	180	15.9	2	19.05	4	205
PLC - 80	80	3"	298	152.4	127	190	17.5	2	19.05	4	205
PLC - 100	100	4"	352	190.5	157.2	230	22.3	2	19.05	8	240

* "X" Dimension only 3/2 Way Valve

(All Dimensions are in mm)



Pneumatic - Pneumatic & Electro Pneumatic ROTARY Valve Positioner



Electro - Pneumatic
Model AEP-1000-R

Input Signal : 4 ~ 20 mA DC
Supply Air Pressure : 20 ~ 100 psi Max. (7.0 Kg/cm²)
Standard Stroke : 10 ~ 80 mm
Air Pipe Connection : 1/4" NPT
Ambient Temperature : -20 °C to 70 °C
Degree of Protection : IP 65
Out-put Characteristics : Rotary
Conduit Connection : 1/2" NPT
Body Material : Aluminium Die Cast



Pneumatic - Pneumatic
Model APP-1200-RDN



Pneumatic - Pneumatic & Electro Pneumatic LINEAR Valve Positioner



Electro - Pneumatic
Model AEP-1000-LSN

Input Signal : 3 ~ 15 (0.2 ~ 1.0 Kg/cm²)
Supply Air Pressure : 100 psi Max. (7.0 Kg/cm²)
Standard Stroke : 10 ~ 80 mm
Air Pipe Connection : 1/4" NPT
Ambient Temperature : -20 °C to 70 °C
Degree of Protection : IP 65
Out-put Characteristics : Linear
Conduit Connection : 1/2" NPT
Body Material : Aluminium Die Cast



Pneumatic - Pneumatic
Model APP-1200-LSN



SMART Positioner LINEAR



Model : IP 6000 Series
Body : Aluminium
Set Point Signal : 4 - 20mA DC
Ambient Temperature : Normal Version : -20 °C ~ 70 °C
 Optional Version : -40 °C ~ 70 °C
Supply Pressure : 0.14 - 0.7 MPa
Flow : 55L/min (Sup=0.14MPa)



Weatherproof MICRO Limit Switch Box



Model : MMLS-BX-WP-01-A
 MMLS-BX-WP-01-B
 MMLS-BX-WP-01-C
Switch : Honeywell ZM / NJ2-V3-N / NBB-V3-Z4
Type : 1 NO + 1 NC / 2 Switch
Enclosure Protection : IP 67
Ambient Temperature : -20 °C to 80 °C
Conduit Entry : 1/2" - NPT
Terminal : 8 Point
Mounting Bracket : Namur VDI / VDE3845 / ISO 5211
Material : Aluminium Die Cast



Flameproof Limit Switch Box



Model : MLS-BX-FLP-01-A
 MLS-BX-FLP-01-B
 MLS-BX-FLP-01-C
 MLS-BX-FLP-01-D
Switch : Honeywell V15 / Honeywell V 15 PCB Type / NCB2-V3-NO / NJ2-V3-N / NBB-V3-Z4 / NBB3-V3-Z4
Type : 1 NO + 1 NC / 2 NO + 2 NC / 2 Switch
Enclosure Protection : IP 68
Ambient Temp. : -20 °C to 80 °C
Conduit Entry : 1/2" - NPT
Terminal : 8 Point
Mounting Bracket : Namur VDI / VDE3845 / ISO 5211
Material : Aluminium Die Cast



Flameproof Limit Switch Box STAINLESS STEEL 304 / 316



Model : LS4-BX-FLP-01-A / LS6-BX-FLP-01-A
 LS4-BX-FLP-01-B / LS6-BX-FLP-01-B
 LS4-BX-FLP-01-C / LS6-BX-FLP-01-C
 LS4-BX-FLP-01-D / LS6-BX-FLP-01-D
Switch : Honeywell V15 / Honeywell V 15 PCB Type / NCB2-V3-NO / NJ2-V3-N / NBB-V3-Z4 / NBB3-V3-Z4
Type : 1 NO + 1 NC / 2 NO + 2 NC / 2 Switch
Enclosure Protection : IP 67
Ambient Temp. : -20 °C to 80 °C
Conduit Entry : 1/2" - NPT
Terminal : 8 Point
Mounting Bracket : Namur VDI / VDE3845 / ISO 5211
Material : ASTM A351 Gr. CF8 / CF8M / CF3M



Weatherproof Limit Switch Box (Big Box)



Model : MLS4-BX-01-A / MLS4-BX-01-B
 MLS4-BX-01-C / MLS4-BX-01-D
Switch : Honeywell V 15 / NJ2-V3-N / NBB-V3-Z4 / NCB2-V3-NO
Type : 1 NO + 1 NC / 2 NO + 2 NC / 2 Switch
Enclosure Protection : IP 67
Ambient Temperature : -20 °C to 80 °C
Conduit Entry : 1/2" - NPT
Terminal : 8 Point
Mounting Bracket : Namur VDI / VDE3845 / ISO 5211
Material : Aluminium Die Cast



Weatherproof Limit Switch Box STAINLESS STEEL 304 / 316



Model : MLS4-BX-01-A / MLS4-BX-01-B
 MLS4-BX-01-C / MLS4-BX-01-D
Switch : Honeywell V 15 / NJ2-V3-N / NBB-V3-Z4 / NCB2-V3-NO
Type : 1 NO + 1 NC / 2 NO + 2 NC / 2 Switch
Enclosure Protection : IP 67
Ambient Temperature : -20 °C to 80 °C
Conduit Entry : 1/2" - NPT
Terminal : 8 Point
Mounting Bracket : Namur VDI / VDE3845 / ISO 5211
Material : ASTM A351 Gr. CF8 / CF8M / CF3M



3/2 Way Namur Direct Acting Solenoid Valve

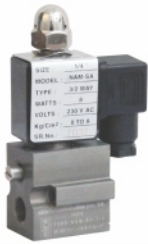

Model	: NAM-SA-32
Coil Voltage	: All Std. Voltage Available
Frequency	: 50 - 60 Hz
Connection Type	: 1/4" (NPT)
Conduit	: PF 1/2"
Coil Insulation Grade	: Class "F"
Ambient Temp.	: -20 °C ~ 70 °C
MOC	: Aluminium
Seals	: NBR (Viton On Request)
Working Pressure	: Upto 0 to 10 Kg/cm ²

5/2 Way Convertible Poppet Type SINGLE & DOUBLE Namur Solenoid Valve



Model	: OTX-ALU-52 / 20TX-ALU-52
Coil Voltage	: All Std. Voltage Available
Frequency	: 50 - 60 Hz
Connection Type	: 1/4" (NPT)
Conduit	: PF 1/2"
Coil Insulation Grade	: Class "F"
Ambient Temp.	: -20 °C ~ 70 °C
MOC	: Aluminium
Seals	: NBR (Viton On Request)
Working Pressure	: Upto 2.5 to 10 Kg/cm ²

3/2 Way Internal Pilot Operated STAINLESS STEEL 316 Single Namur Solenoid Valve



Model	: MPT-S6-32
Coil Voltage	: All Std. Voltage Available
Frequency	: 50 - 60 Hz
Connection Type	: 1/4" (NPT)
Conduit	: PF 1/2"
Coil Insulation Grade	: Class "F" & "H"
Ambient Temp.	: -20 °C ~ 70 °C
MOC	: ASTM A351 Gr. CF8M
Seals	: NBR (Viton On Request)
Working Pressure	: Upto 2.5 to 10 Kg/cm ²

5/2 Way Poppet Type STAINLESS STEEL 316 Single Namur Solenoid Valve



Model	: OTX-S6-52
Coil Voltage	: All Std. Voltage Available
Frequency	: 50 - 60 Hz
Connection Type	: 1/4" (NPT)
Conduit	: PF 1/2"
Coil Insulation Grade	: Class "F" & "H"
Ambient Temp.	: -20 °C ~ 70 °C
MOC	: ASTM A351 Gr. CF8M
Seals	: NBR (Viton On Request)
Working Pressure	: Upto 2.5 to 10 Kg/cm ²

3/2 Way Midget Type Direct Acting Solenoid Valve



Model	: DMV
Size	: 1/4"
Body	: CF8 / CF8M / Brass / S.S 304
Orific	: 2
Pressure	: 7 Kg / cm ²
Temp.	: Upto -5 to 80 °C max.
Coil Rating	: Continuous Rated
Coil Insulation	: "F" Class & "H" Class For Flameproof
Media	: Air & Gas
Voltage	: 12V, 24V, 48V, 110V, 230V, AC/DC

3/2 Way Midget Type Direct Acting Solenoid Valve



Model	: MDV
Size	: 1/4"
Body	: CF8 / CF8M / Brass / S.S 304
Orific	: 2
Pressure	: 7 Kg / cm ²
Temp.	: Upto -5 to 80 °C max.
Coil Rating	: Continuous Rated
Coil Insulation	: "F" Class & "H" Class For Flameproof
Media	: Air & Gas
Voltage	: 12V, 24V, 48V, 110V, 230V, AC/DC

Filter + Regulator Air Combination



Model	: 4FQ / 8 FQ / FRJ / AFRS4
Air Connection	: 1/4"
Max. Supply Pressure	: 4FQ : 0.5 to 4 Kg / cm ² 8FQ : 0.5 to 8 Kg / cm ² FRJ : 1 to 9 Kg / cm ²
Gauge Connection	: 1/8"
Ambient Temp.	: -20 °C ~ 70 °C
Mini Filtering Size	: 5 Micron
Material	: Aluminium Pressure Die Cast / CF8 / CF8M

Air Volume Booster



Model	: VLB
Size	: 1/4" to 1"
MOC	: Aluminium
Seals	: NBR
Supply Pressure	: 10 Bar
Output Pressure	: 7 Bar
Temperature	: -20 °C ~ 70 °C

Single & Double Air Lock Valve



Model Single	: SALV
Model Double	: DALV
Size	: 1/4" to 3/4"
MOC	: Aluminium
Seals	: NBR
Supply Pressure	: 10 Bar
Output Pressure	: 7 Bar
Temperature	: -20 °C ~ 70 °C

Manual Override Clutch Type (MO)



Model	: AMO
Torque	: 200 Nm to 10000 Nm
Body	: Aluminium Pressure Die Cast / S. G. Iron
Lever Wheel	: Stainless Steel
Hand Wheel	: S.S. / M.S. (Fabricated)

Installations

- Indian Oil
- Reliance Industries Limited
- ONGC
- Hindalco
- Godrej
- Indian Railway
- Vedanta
- Voltas
- NTPC
- Gujarat State Fertilizers & Chemical Ltd.
- L & T
- Gail
- Hindustan Petroleum
- BHEL
- IFFCO
- BARC
- Thermax
- Essar

Application

- Process & Chemical
- Refineries & Petrochemicals
- Drugs & Pharmaceuticals
- Thermal Power Stations
- Dyes & Intermediates
- Breweries & Distilleries
- Steel Plants
- Onshore & Offshore Platforms
- Steel Plants
- Solvent Extraction Plants
- Sewage
- Cooling Water
- Ship Yards & Marine Management
- LPG Bottling Plants
- Water Works
- Pulp & Paper
- Fertilizers
- Textiles
- Sugar
- Nuclear & Atomic Power Stations
- Paints & Varnishes
- Soaps & Detergents
- Slurry & Ash handling
- Food & Oil Industry
- Effluent & Water Treatment

This Product is Generally made to use on the High Pressure Piping System, It is Widely Applied for Major Industrial Sectors

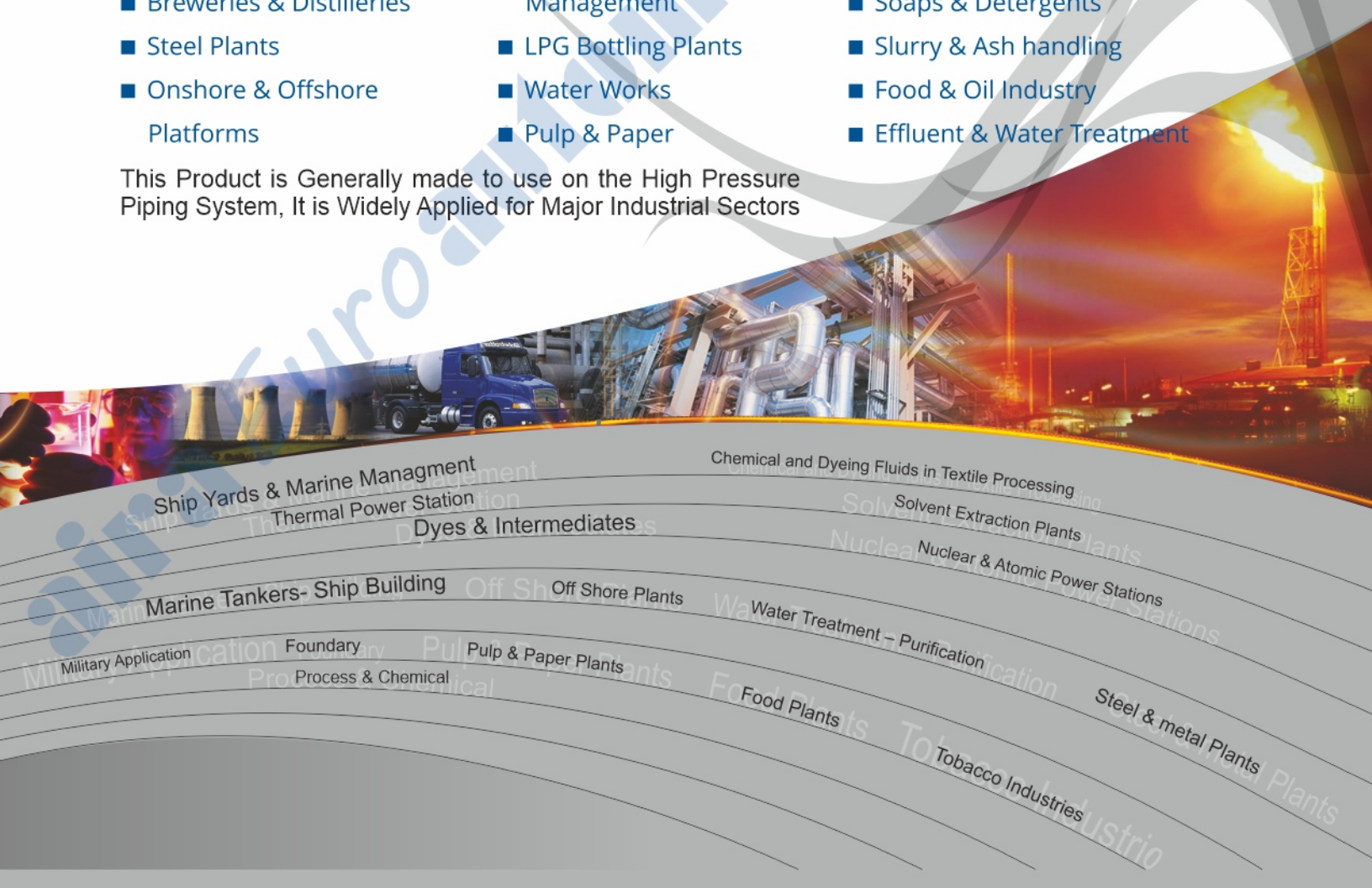

Ship Yards & Marine Management
Thermal Power Station

Dyes & Intermediates

Marine Tankers- Ship Building

Off Shore Plants

Military Application

Foundary

Pulp & Paper Plants

Process & Chemical

Water Treatment - Purification

Food Plants

Tobacco Industries

Steel & metal Plants

Chemical and Dyeing Fluids in Textile Processing

Solvent Extraction Plants

Nuclear & Atomic Power Stations



time tested designs with superior performance

GLOBAL

Network

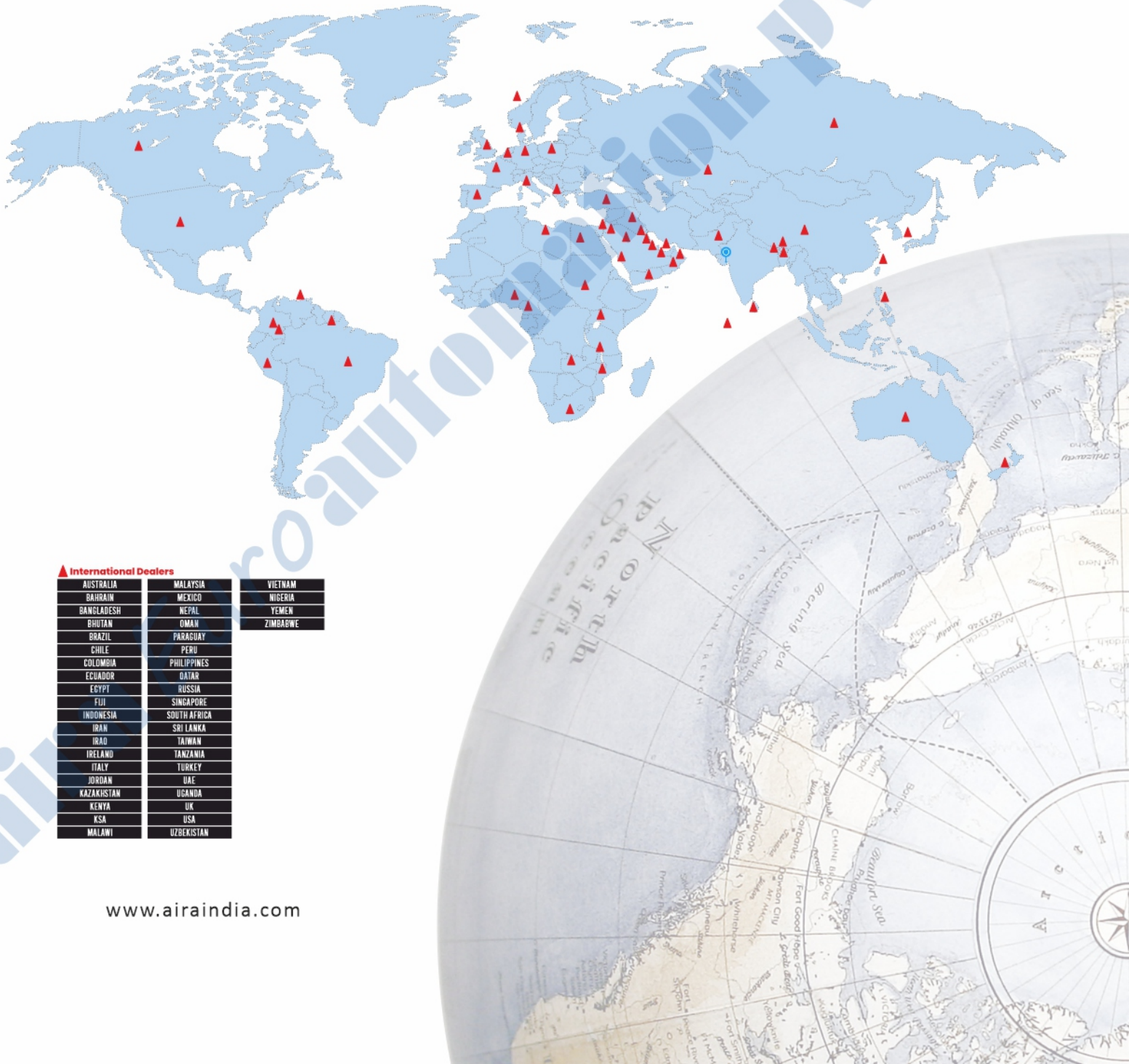

▲ International Dealers

AUSTRALIA	MALAYSIA	VIETNAM
BAHRAIN	MEXICO	NIGERIA
BANGLADESH	NEPAL	YEMEN
BHUTAN	OMAN	ZIMBABWE
BRAZIL	PARAGUAY	
CHILE	PERU	
COLOMBIA	PHILIPPINES	
ECUADOR	QATAR	
EGYPT	RUSSIA	
FUJI	SINGAPORE	
INDONESIA	SOUTH AFRICA	
IRAN	SRI LANKA	
IRAQ	TAIWAN	
IRELAND	TANZANIA	
ITALY	TURKEY	
JORDAN	UAE	
KAZAKHISTAN	UGANDA	
KENYA	UK	
KSA	USA	
MALAWI	UZBEKISTAN	



industrial valve automation

Network

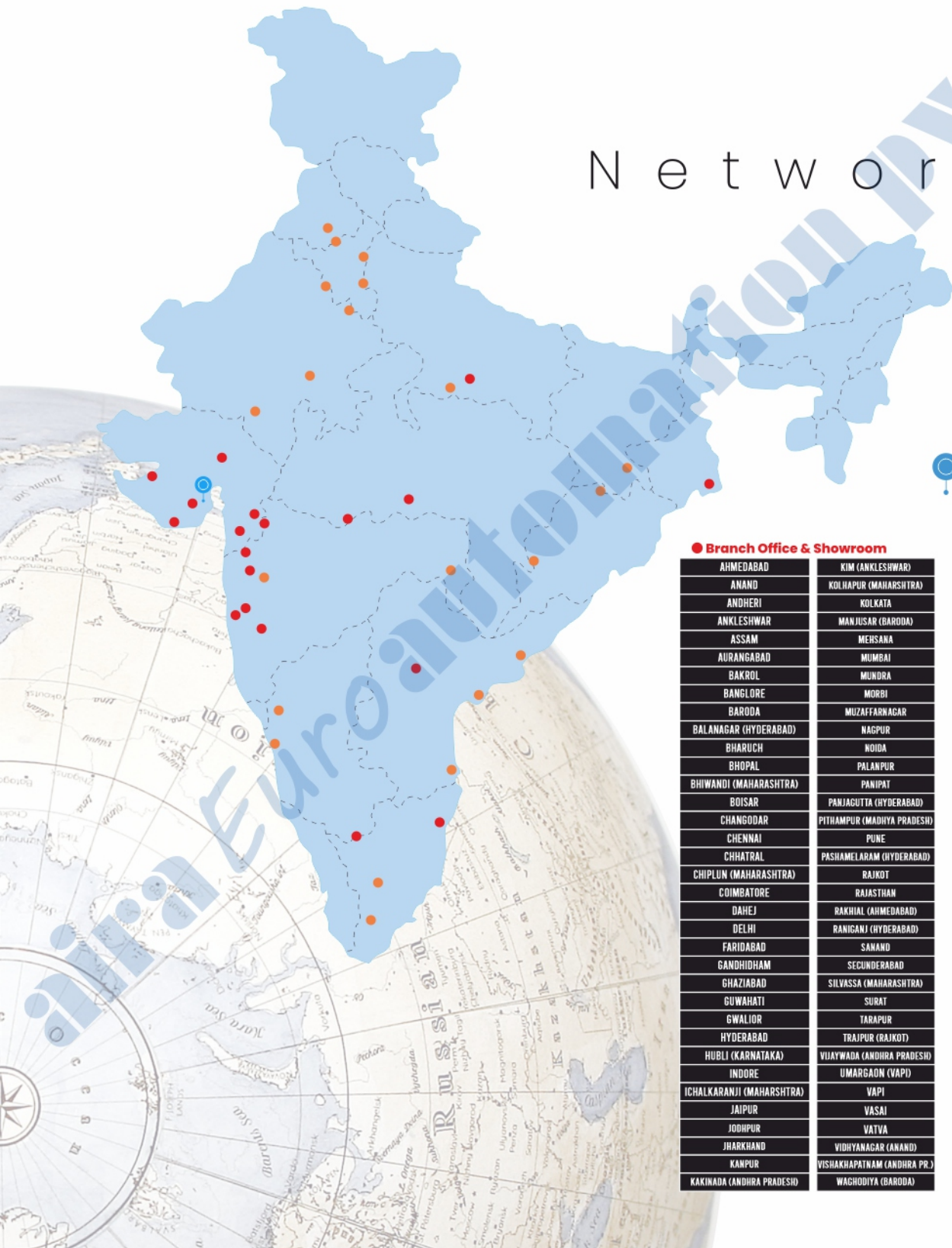

Head Office & Works
AHMEDABAD

● Branch Office & Showroom

AHMEDABAD	KIM (ANKLESHWAR)
ANAND	KOLHAPUR (MAHARASHTRA)
ANDHERI	KOLKATA
ANKLESHWAR	MANJUSAR (BARODA)
ASSAM	MEHSANA
AURANGABAD	MUMBAI
BAKROL	MUNDRA
BANGLORE	MORBI
BARODA	MUZAFFARNAGAR
BALANAGAR (HYDERABAD)	NAGPUR
BHARUCH	NOIDA
BHOPAL	PALANPUR
BHIWANDI (MAHARASHTRA)	PANIPAT
BOISAR	PANJAGUTA (HYDERABAD)
CHANGODAR	PITHAMPUR (MADHYA PRADESH)
CHENNAI	PUNE
CHHATRAL	PASHIMELARAM (HYDERABAD)
CHIPLUN (MAHARASHTRA)	RAJKOT
COIMBATORE	RAJASTHAN
DAHEJ	RAKHIAL (AHMEDABAD)
DELHI	RANIGANJ (HYDERABAD)
FARIDABAD	SANAND
GANDHIDHAM	SECUNDERABAD
GHAZIABAD	SILVASSA (MAHARASHTRA)
GUWAHATI	SURAT
GWALIOR	TARAPUR
HYDERABAD	TRAJIPUR (RAJKOT)
HUBLI (KARNATAKA)	VIJAYWADA (ANDHRA PRADESH)
INDORE	UMARGAON (VAPI)
ICHALKARANJI (MAHARASHTRA)	VAPI
JAIPUR	VASAI
JODHPUR	VATVA
JHARKHAND	VIDHYANAGAR (ANAND)
KANPUR	VISHAKHAPATNAM (ANDHRA PR.)
KAKINADA (ANDHRA PRADESH)	WAGHOZIYA (BARODA)

● Dealers & Distributors

AMRITSAR	KOLKATA
BALOTA	LUCKNOW
BANGLORE	LUDHIANA
BELGAUM	MARWAR
BHILWARA	MEERUT
CHANDICARH	MUZAFFARNAGAR
CHENNAI	NAGPUR
COCHIN	NOIDA
COIMBATORE	PANIPAT
DELHI	PEENYA
ERODE	PUNE
FARIDABAD	TRIPUR
GHAZIABAD	VARANASI
GOA	VISAKHAPATNAM
INDORE	WADI
JALANDHAR	KANPUR
JAMSHEDPUR	KOLHAPUR
JHARKHAND	

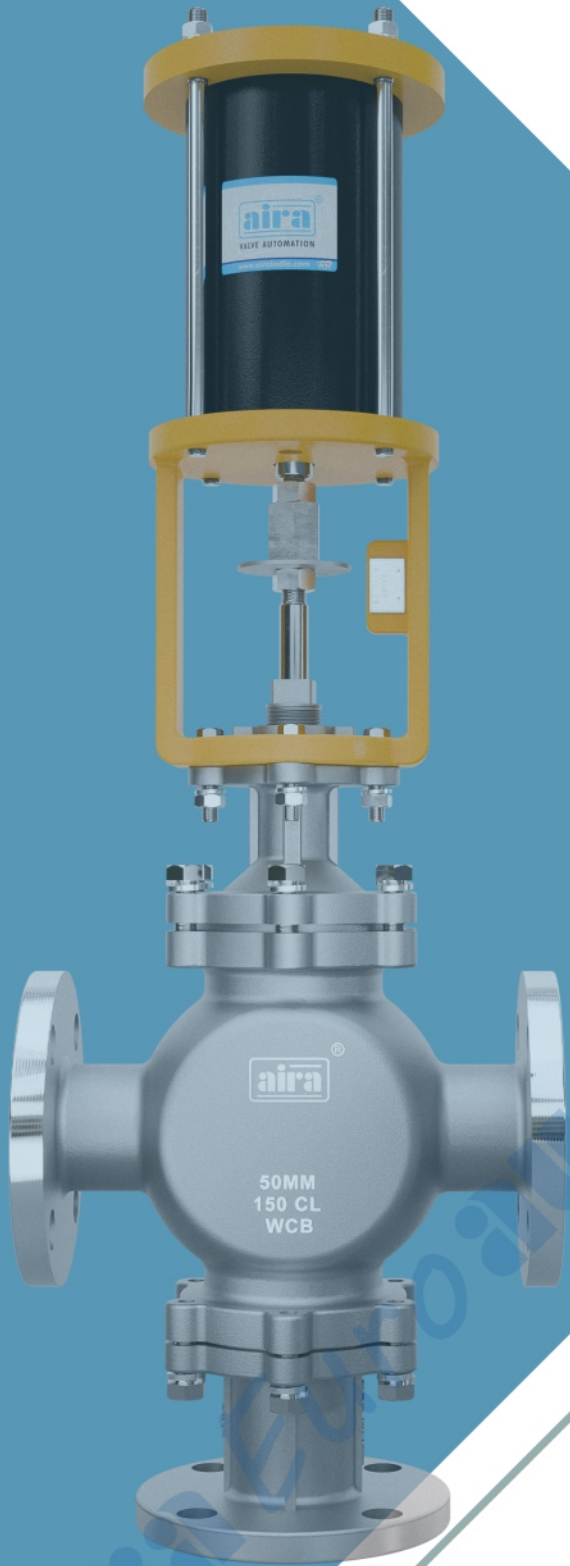

aira[®]
VALVE AUTOMATION



Mfg. & Mkt by
aira Euroautomation pvt. Ltd.

INDIA

www.airaindia.com